

BC - Locating bearing, blind shaft

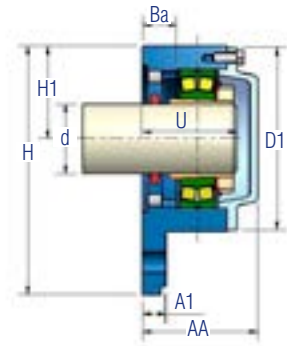

LC - Non-locating bearing, blind shaft

- See page 14 for technical features.
- Standard seal "TC" – felt strip, see page 04.
- **Specification example:** F-515-BC + 1 FRB-10/130 = F-500 housing, size 515, made of grey cast iron, for locating bearing and blind shaft, for bearings type 2215-K or 22215-K.
- When ordering, always indicate the bearings or locating rings used.
- For shafts with diameters in inches please contact our engineering department and specify on order form, otherwise it shall be manufactured in millimeters, as it is the standard measure for this series.
- One felt strip for housing type A and two felt strips for housing type B should be used.

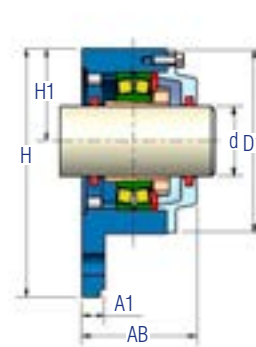

BP - Locating bearing, passing shaft

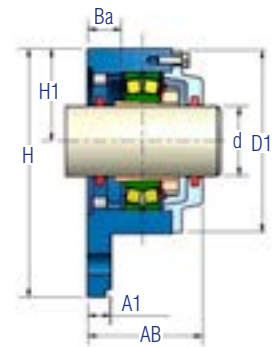

LP - Non-locating bearing, passing shaft

Housing	Shaft d	Bearing designation	Adapter sleeve	Lock ring		Dimensions (mm)											Felt	Weight (kg)	
				Qty.	Specification	AA	AB	A1	Ba	Bb	D1	H	H1	E	L	S			U
F-505	20	1205K	H 205	1	FRB 5/52	51,5	56,5	10	15	12,5	75	100	38	96	110	10	45	FS110	1,1
		2205K	H 305	1	ZW 42x52														
		22205K	H 305	1	ZW 42x52														
F-506	25	1206K	H 206	1	FRB 6/62	57	59,5	12	16	15	86	117	44	116	130	10	49	FS190	1,5
		2206K	H 306	1	ZW 50x62														
		22206K	H 306	1	ZW 50x62														
F-507	30	1207K	H 207	1	FRB 8/72	59,5	63,5	12	16	14,5	97	130	48,5	130	145	12	52	FS190	1,8
		2207K	H 307	1	ZW 65x72														
		22207K	H 307	1	ZW 65x72														
F-508	35	1208K	H 208	1	FRB 7/80	64	65,5	12	17	18	108	143	54	140	160	12	53,5	FS190	2,9
		2208K	H 308	1	ZW 70x80														
		22208K	H 308	1	ZW 70x80														
F-509	40	1209K	H 209	1	FRB 6/85	64,5	69,5	12	19	16,5	113	160	60	160	180	12	56	FS190	3,1
		2209K	H 309	1	ZW 75x85														
		22209K	H 309	1	ZW 75x85														
F-510	45	1210K	H 210	1	FRB 5/90	68,5	73	15	22	17,5	118	160	60	160	180	12	61	FS190	3,8
		2210K	H 310	1	ZW 80x90														
		22210K	H 310	1	ZW 80x90														
F-511	50	1211K	H 211	1	FRB 6/100	75,5	81,5	15	24	19,5	128	172	65	170	192	12	66	FS260	4
		2211K	H 311	1	ZW 85x100														
		22211K	H 311	1	ZW 85x100														
F-512	55	1212K	H 212	1	FRB 8/110	77	82	15	23	19	142	189	72	180	210	12	68	FS260	4,6
		2212K	H 312	1	ZW 90x110														
		22212K	H 312	1	ZW 90x110														
F-513	60	1213K	H 213	1	FRB 10/120	80	86	15	22	20	152	203	78	190	225	12	71	FS260	6
		2213K	H 313	1	FRB 2/120														
		22213K	H 313	1	FRB 2/120														

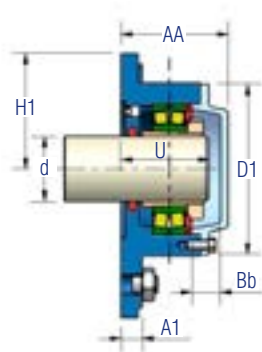
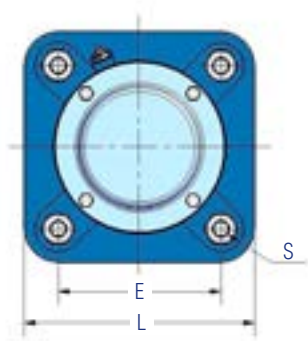

BC - Locating bearing, blind shaft

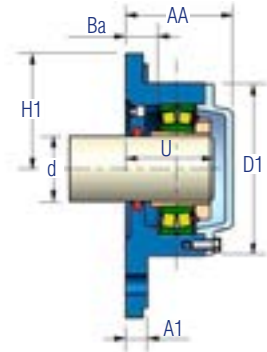

LC - Non-locating bearing, blind shaft

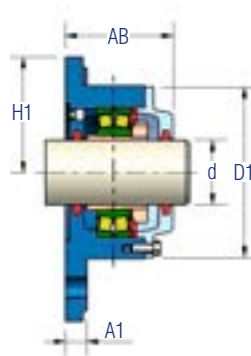

BP - Locating bearing, passing shaft

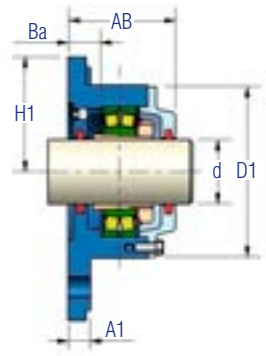

LP - Non-locating bearing, passing shaft

- See page 14 for technical features.
- Standard seal "TC" – felt strip, see page 04.
- **Specification example:** F-515-BC + 1 FRB-10/130 = F-500 housing, size 515, made of grey cast iron, for locating bearing and blind shaft, for bearings type 2215-K or 22215-K.
- When ordering, always indicate the bearings or locating rings used.
- For shafts with diameters in inches please contact our engineering department and specify on order form, otherwise it shall be manufactured in millimeters, as it is the standard measure for this series.
- One felt strip for housing type A and two felt strips for housing type B should be used.

Housing	Shaft d	Bearing designation	Adapter sleeve	Lock ring		Dimensions (mm)										Felt	Weight (kg)	
				Qty.	Specification	AA	AB	A1	Ba	Bb	D1	H1	E	L	S			U
F-515	65	1215K	H 215	2	FRB 8/130	104	104	25	30	27	168	95	152	190	16	93	FS260	10
		2215K	H 315	1	FRB 10/130													
		22215K	H 315	1	FRB 10/130													
F-516	70	1216K	H 216	2	FRB 8,5/140	110	110	25	31	30	176	98	152	196	16	96	FS330	10,3
		2216K	H 316	1	FRB 10/140													
		22216K	H 316	1	FRB 10/140													
F-517	75	1217K	H 217	2	FRB 9/150	114	114	25	31	30	188	105	170	210	16	72	FS330	12,6
		2217K	H 317	1	FRB 10/150													
		22217K	H 317	1	FRB 10/150													
F-518	80	1218K	H 218	2	FRB 10/160	118	118	25	30	31	198	105	170	210	16	105	FS330	13
		2218K	H 318	1	FRB 10/160													
		22218K	H 318	1	FRB 10/160													
F-520	90	1220K	H 220	2	FRB 11/180	127	127	30	30	33	224	125	198	250	20	113	FS370	20
		2220K	H 320	1	FRB 10/180													
		22220K	H 320	1	FRB 10/180													
F-522	100	1222K	H 222	2	FRB 12,5/200	137	137	30	30	38	246	135	219	270	20	123	FS460	22
		2222K	H 322	1	FRB 10/200													
		22222K	H 322	1	FRB 10/200													